Micro Focus Security

ArcSight Logger Quick Start

Software Version: 6.71

Quick Start Guide

Document Release Date: May, 2019

Software Release Date: May, 2019



Legal Notices

Warranty

The only warranties for products and services of Micro Focus and its affiliates and licensors (“Micro Focus”) are set forth in the express warranty statements accompanying such products and services. Nothing herein should be construed as constituting an additional warranty. Micro Focus shall not be liable for technical or editorial errors or omissions contained herein. The information contained herein is subject to change without notice.

Restricted Rights Legend

Confidential computer software. Except as specifically indicated otherwise, a valid license from Micro Focus is required for possession, use or copying. Consistent with FAR 12.211 and 12.212, Commercial Computer Software, Computer Software Documentation, and Technical Data for Commercial Items are licensed to the U.S. Government under vendor's standard commercial license.

Copyright Notice

© Copyright 2019 Micro Focus or one of its affiliates.

Trademark Notices

Adobe™ is a trademark of Adobe Systems Incorporated.

Microsoft® and Windows® are U.S. registered trademarks of Microsoft Corporation.

UNIX® is a registered trademark of The Open Group.

Support

Contact Information

Phone	A list of phone numbers is available on the Technical Support Page: https://softwaresupport.softwaregrp.com/support-contact-information
Support Web Site	https://softwaresupport.softwaregrp.com/
ArcSight Product Documentation	https://community.softwaregrp.com/t5/ArcSight-Product-Documentation/ct-p/productdocs

Document Revision History

The title page of this document contains the following identifying information:

- Software Version number, which indicates the software version.
- Document Release Date, which changes each time the document is updated.

To check for recent updates or to verify that you are using the most recent edition of a document, go to the : [ArcSight Product Documentation Community on Protect 724](#).

Document Changes

Date	Product Version	Description

About this PDF Version of Online Help

This document is a PDF version of the online help. This PDF file is provided so you can easily print multiple topics from the help information or read the online help in PDF format. Because this content was originally created to be viewed as online help in a web browser, some topics may not be formatted properly. Some interactive topics may not be present in this PDF version. Those topics can be successfully printed from within the online help.

Contents

- About this Guide 6

- Chapter 1: Overview 7
 - How Logger Quick Start Works 7
 - Logger Quick Start for Security, Compliance, and IT Operations 8

- Chapter 2: Installing and Configuring Logger Quick Start 10
 - Before You Install 10
 - Trial License 11
 - How Licensing Works 11
 - Viewing Your License 11
 - Prerequisites for Installation 11
 - Increasing the User Process Limit 13
 - Installing the Trial Logger Quick Start 13
 - Installing Trial Logger Quick Start on a Linux System 14
 - Installing Trial Logger Quick Start for VMware VM 17
 - Preparing the Virtual Machine 17
 - Installing the Trial Logger Quick Start on the Virtual Machine 18
 - Connecting to Logger Quick Start 21
 - Initial Logger Quick Start Configuration 22
 - Starting and Stopping Logger Quick Start 23
 - Uninstalling Logger Quick Start 24

- Chapter 3: Receiving Events and Logs 25
 - Enabling the Preconfigured Receivers 25
 - Configuring New Receivers 27
 - Sending Structured Data to Logger Quick Start 28
 - Configuring a SmartConnector to Send Events to Logger Quick Start 28

- Chapter 4: Overview of the Logger Quick Start User Interface 30
 - Navigating the User Interface 30
 - Take Me To 30
 - Server Clock, Current User, and Options Dropdown 31

The Options Page	32
Logout	32
Summary	33
Dashboards	33
Chapter 5: Searching for Events	34
Example Queries	34
Syntax of a Query	35
Building a Query	36
Run a Query	36
Query Building Tools	37
Exporting Search Results	38
Saving Queries for Later Use	39
System Filters (Predefined Filters)	39
Tuning Search Performance	40
Chapter 6: Alerts	41
Types of Alerts	41
Configuring Alerts	42
Chapter 7: Other Logger Quick Start Features	43
Scheduling Tasks	43
Archiving Events	43
Access Control on Logger Quick Start Users	43
Enriching Data Through Static Correlation	44
Web Services	44
Chapter 8: Example Queries	45
Send Documentation Feedback	46

About this Guide

This guide enables you to install and start using the trial version of ArcSight Logger Quick Start in a matter of minutes. You do not require any prior knowledge of Logger Quick Start to use the product or to understand information in this document; however, you should be familiar with the log management concept.

The goal of this guide is to enable you to start using Trial Logger Quick Start quickly. For an in-depth discussion of Logger Quick Start, or any of its features, refer to the online Help available with the product or to the ArcSight Logger Quick Start Administrator's Guide.

Chapter 1: Overview

ArcSight Logger Quick Start is a log management solution that is optimized for extremely high event throughput, efficient long-term storage, and rapid data analysis. An event is a time-stamped text message, either a syslog message sent by a host or a line appended to a log file. Logger Quick Start receives and stores events; supports search, retrieval, and reporting; and can forward selected events for correlation and analysis to destinations such as a syslog server.

Note: The features available on Logger Quick Start vary by version and license. Certain Logger Quick Start features mentioned in this guide are not available in the trial version. These are indicated by *italic* font.

The trial version of Logger Quick Start is available in two form factors, as software and as a virtualized image. The form factors offer identical features. Trial Logger Quick Start can be installed on a supported Linux platform of your choice. Trial Logger Quick Start for VMware VM includes the Trial Logger Quick Start installation files and a pre-installed operating system to enable quick deployment on an ESXi server.

- [How Logger Quick Start Works](#) 7
- [Logger Quick Start for Security, Compliance, and IT Operations](#) 8

How Logger Quick Start Works

Logger Quick Start stores time-stamped text messages, called events, at high, sustained-input rates. Logger Quick Start compresses raw data, but can always retrieve unmodified data on demand, for forensics-quality litigation data. Logger Quick Start can receive data in the form of normalized CEF events from ArcSight SmartConnectors, syslog messages, and log files directly from a device. Logger Quick Start can then forward received events to a syslog server or *ArcSight ESM*.

SmartConnectors are the interface between Logger Quick Start and devices on your network that generate events you want to store on Logger Quick Start. SmartConnectors collect event data and normalize it into a Common Event Format (CEF). For more information about CEF, search for “ArcSight Common Event Format (CEF) Guide” in the [ArcSight Product Documentation Community on Protect 724](#), and refer to "Implementing ArcSight CEF."

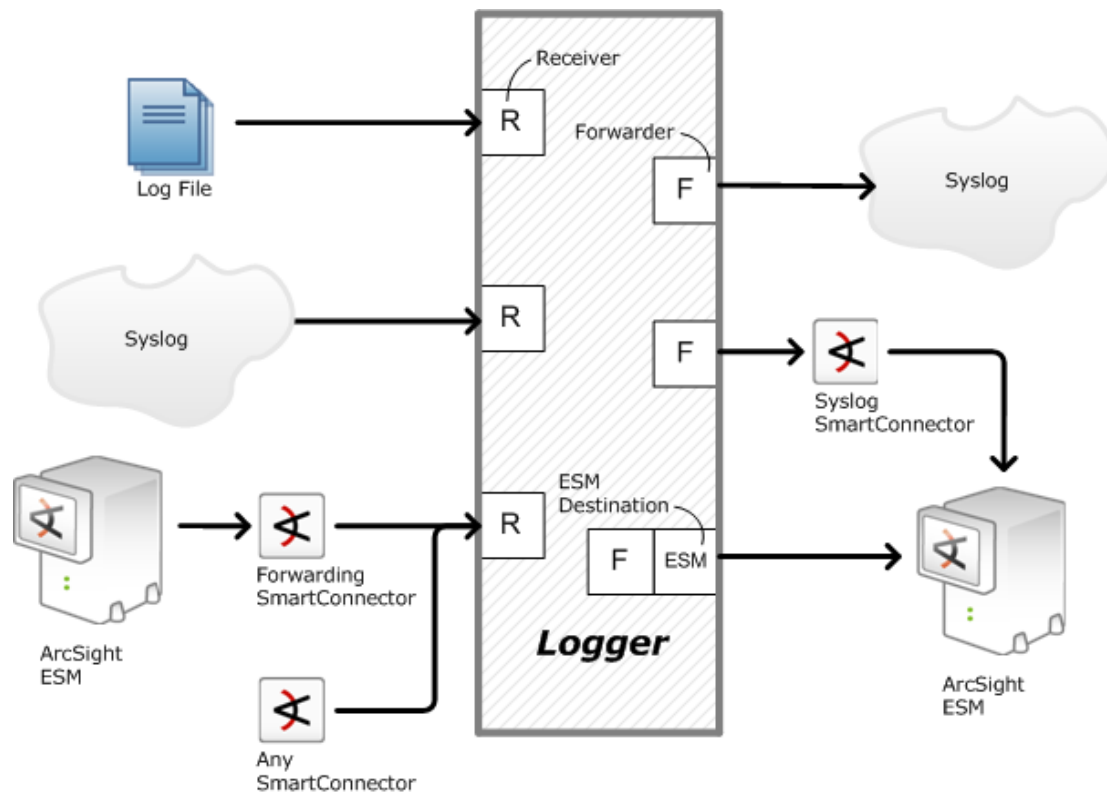

Once events have been stored on a Logger Quick Start, you can do the following:

- Search for events that match a specific query.
- *Generate reports of events of interest.**
- Generate alerts when a specified number of matches occur within a given time threshold. Alerts can notify you by e-mail, an SNMP trap, or a Syslog message.
- Establish dashboards that display events that match a specific query.
- *Forward selected events to ArcSight ESM for correlation and analysis.**
- Forward events to a syslog server.

** The trial version of Logger differs from the Enterprise version of Logger in that it does not include Forwarding Connectors, the Reporting feature, support for Peering, or remote management via ArcSight Management Center. To take advantage of these features, purchase and install an Enterprise version of Logger.*

Logger Quick Start for Security, Compliance, and IT Operations

Although Logger Quick Start's applicability spans a wide array of industries, its search, *reporting*, and alerting capabilities are directly applicable to security and compliance reporting, and for IT operations search.

Logger Quick Start ships with predefined content filters that define queries for commonly searched security, IT operations, and application development events. These include unsuccessful login attempts, the number of events by source, and SSH authentications on UNIX servers. Therefore, you do not need to define queries to search for many commonly searched events. You can also copy the predefined content filters and modify them to suit your needs, thus saving time and effort required to start writing queries from scratch. In addition, *Logger also contains predefined reports for common security and device monitoring use cases.*

For a complete list of predefined content filters *and predefined reports*, refer to the ArcSight Logger Quick Start Administrator's Guide. Information about how to use predefined filters is included in ["System Filters \(Predefined Filters\)" on page 39](#).

Chapter 2: Installing and Configuring Logger Quick Start

This chapter explains what you need to know to install and start running Trial Logger Quick Start on a LINUX system or on a VMware VM.

- [Before You Install](#) 10
- [Installing the Trial Logger Quick Start](#) 13
- [Connecting to Logger Quick Start](#) 21
- [Initial Logger Quick Start Configuration](#) 22
- [Starting and Stopping Logger Quick Start](#) 23
- [Uninstalling Logger Quick Start](#) 24

Before You Install

You need to have a server with supported operating system and storage available to install the Trial Logger Quick Start. For more information about the platforms on which you can install and use Logger Quick Start, refer to the Release Notes and Support Matrix for your version. These documents are available for download from the [ArcSight Product Documentation Community on Protect 724](#).

You can deploy the Logger Quick Start virtual machine (VM) on a VMware ESXi server, version 5.5. The VM image includes the Logger Quick Start 6.71 Trial installer on a 64-bit CentOS configured with 12 GB RAM and four physical (and eight logical) cores.

The installation package is available for download from the Micro Focus Software Depot at <https://h20392.www2.hpe.com/portal/swdepot/index.do>.

Micro Focus provides a digital public key to enable you to verify that the signed software you received is indeed from Micro Focus and has not been manipulated in any way by a third party.

Visit the following site for information and instructions:

<https://h20392.www2.hpe.com/portal/swdepot/displayProductInfo.do?productNumber=HPLinuxCodeSigning>

- [Trial License](#) 11
- [Prerequisites for Installation](#) 11

Trial License

Trial Logger Quick Start includes a built-in trial license that you can use for a limited period of time for test and evaluation purposes. To use Logger Quick Start after the trial period is over or to access Logger Quick Start's full feature set, you must purchase and install the Enterprise version. Contact your Micro Focus ArcSight sales representative for details.

Note: The Trial Logger Quick Start cannot be migrated or upgraded to an Enterprise version of Logger Quick Start. Be sure to use an Enterprise version when deploying Logger Quick Start on a production system.

How Licensing Works

The license for Logger Quick Start defines its Daily Data limit—a per day limit on the amount of incoming data. For example, the limit might be 5 GB per day. The sum of the sizes of the events is used to determine this value.

When a data limit violation occurs, the Search user interface displays a warning. For a detailed explanation of how licensing works, refer to the Logger Quick Start Administrator's Guide.

Viewing Your License

After installing Logger Quick Start, you can view the specific details of the current license on the **Configuration | Advanced > License Information** page and the **System Administration | System > License & Update page**. For more information, refer to the Logger Quick Start Administrator's Guide.

Prerequisites for Installation

Before installing Trial Logger Quick Start, make sure that the following prerequisites are met:

- Verify that you have the correct installation file, as described in ["Before You Install" on the previous page](#).
- Increase the user process limit, as described in ["Increasing the User Process Limit" on page 13](#).
- Decide whether to install Logger Quick Start while logged in as root or as a non-root user. Your installation options vary depending on which user you choose.
 - A non-root user account must exist on the system on which you are installing Logger Quick Start. When you install as root, a non-root user account is still required.
 - If you are installing Logger Quick Start on a VMware virtual machine (VM), a non-root user—`arcsight`, with no password—comes preconfigured on your VM image.

- If you are installing as a non-root user, the user must have privileges to write to the installation directory and its sub-directories. For example, for the non-root user `arcsight`, use the command `chown -R arcsight:arcsight /opt/arcsight`.
- When you install as root, you can choose to configure Logger to start as a service and select the port on which Logger listens for secure web connections.
- When you install as `arcsight`, the non-root user, Logger can only listen for connections on port `9000/tcp`. You cannot configure the port to a different value.
- The hostname of the machine on which you are installing Logger Quick Start cannot be called `localhost`. If it is, change the hostname before proceeding with the installation.
- Install into an empty folder. If you have uninstalled Logger Quick Start previously, and are installing into the same location, be sure to remove any files that the uninstaller left in place.
- You must not have an instance of MySQL installed on the machine on which you install Logger Quick Start. If an instance of MySQL exists on that machine, uninstall it before installing Logger Quick Start.

Additional prerequisites for installing trial Logger Quick Start on VMWare VM only:

- Boot up the operating system on the VM, log in, set the timezone, and do any other necessary configuration before proceeding with the installation.

Caution: The VM has the default root password `arcsight`. A non-root user—`arcsight`, with no password—is also included. For security reasons and so that you can SCP and SSH to your machine, change the root password and add a password for the `arcsight` user as soon as possible.

- Configure the network on the VM as appropriate for your environment. The hostname must be resolvable, either by the DNS server or by settings in `/etc/hosts`.
- Security-Enhanced Linux (SELinux) and SSH are enabled on the OS, but the firewall is disabled. To ensure proper access to Logger Quick Start, enable a firewall and add your firewall policy to allow or deny devices as soon as possible.

Additional prerequisite for installing Trial Logger on a native Linux system only:

- Ensure that you are installing Logger on a supported platform. Refer to the Release Notes and ArcSight Data Platform Support Matrix for this information. These documents are available for download from the ArcSight Product Documentation Community on [Protect 724](#).
- Ensure that you are installing Logger on a supported platform. Refer to the Release Notes and Product component name Support Matrix for this information. These documents are available for download from the ArcSight Product Documentation Community on [Protect 724](#).
- You must have an X Window System server installed to use the GUI mode of installation. If you will be installing the Trial Software Logger Quick Start over an SSH connection and want to use the GUI mode of installation, make sure that you have enabled X window forwarding using the `-X` option, so that you can view the screens of the installation wizard. If you will be using PuTTY, you will need an X client on both the source and target devices.

Increasing the User Process Limit

Before installing or upgrading Logger Quick Start, you must increase default user process limit while logged in as user root. This ensures that the system has adequate processing capacity.

Note: This change is only necessary when installing Software Logger Quick Start on your own Linux system. It has already been done for Logger Quick Start on VMWare VM.

To increase the default user process limit:

1. Open the file `/etc/security/limits.d/<NN>-nproc.conf`.
(<NN> is 90 for RHEL or CentOS 6.X and 20 for RHEL and CentOS 7.X.)
 - If you do not already have a `/etc/security/limits.d/<NN>-nproc.conf` file, create one (and the `limits.d` directory, if necessary).
 - If the file already exists, delete all entries in the file.

2. Add the following lines:

```
* soft nproc 10240
* hard nproc 10240
* soft nofile 65536
* hard nofile 65536
```

Caution: Be sure to include the asterisk (*) in the new entries. It is important that you add all of the entries exactly as specified. Any omissions can cause system run-time errors.

3. Log out and log back in again.
4. Run the following command to verify the new settings: `ulimit -a`
5. Verify that the output shows the following values for “open files” and “max user processes”:

```
open files 65536
max user processes 10240
```

Installing the Trial Logger Quick Start

This section describes the prerequisites and the procedure for installing Trial Logger Quick Start. Installing the Trial Logger Quick Start software on either platform requires the same basic steps. However, if you are installing Logger Quick Start on a virtual machine, you will need to prepare the virtual machine before installing Logger Quick Start on it.

Overview of steps to install Trial Logger Quick Start:

1. Confirm that you meet the prerequisites for installation as described in ["Prerequisites for Installation" on page 11](#).
2. Install the Logger Quick Start software using the appropriate instructions for your platform.
 - To install Trial Logger Quick Start on a native Linux system, follow the steps in ["Installing Trial Logger Quick Start on a Linux System" below](#).
 - To install Trial Logger Quick Start on VMware VM, follow the steps in ["Installing Trial Logger Quick Start for VMware VM" on page 17](#).

After you finish installing the Logger Quick Start software, you can connect to Logger Quick Start as described in ["Connecting to Logger Quick Start" on page 21](#).

- [Installing Trial Logger Quick Start on a Linux System](#)14
- [Installing Trial Logger Quick Start for VMware VM](#)17

Installing Trial Logger Quick Start on a Linux System

This section describes the procedure for installing Trial Logger Quick Start on a native Linux system. For instructions on how to install Trial Logger Quick Start on a VMware VM, see ["Installing Trial Logger Quick Start for VMware VM" on page 17](#).

Make sure the machine on which you will be installing Trial Logger Quick Start complies with the specifications listed the Release Notes for your version, and that the prerequisites listed in ["Prerequisites for Installation" on page 11](#) are met.

Preinstallation steps:

- Before you install, you must increase the user process limit on the OS, as described in ["Increasing the User Process Limit" on the previous page](#).
- Verify that you have the correct installation file, as described in ["Before You Install" on page 10](#).

You can install Logger Quick Start as a root user or as a non-root user. See ["Prerequisites for Installation" on page 11](#) for details and restrictions.

To install the Logger software:

1. Run these commands from the /opt/arcsight/installers directory:

```
chmod u+x ArcSight-logger-6.2.0.L8213.1.trial.bin
./ArcSight-logger-6.2.0.L8213.1.trial.bin
```
2. The installation wizard launches. Click **Next**.

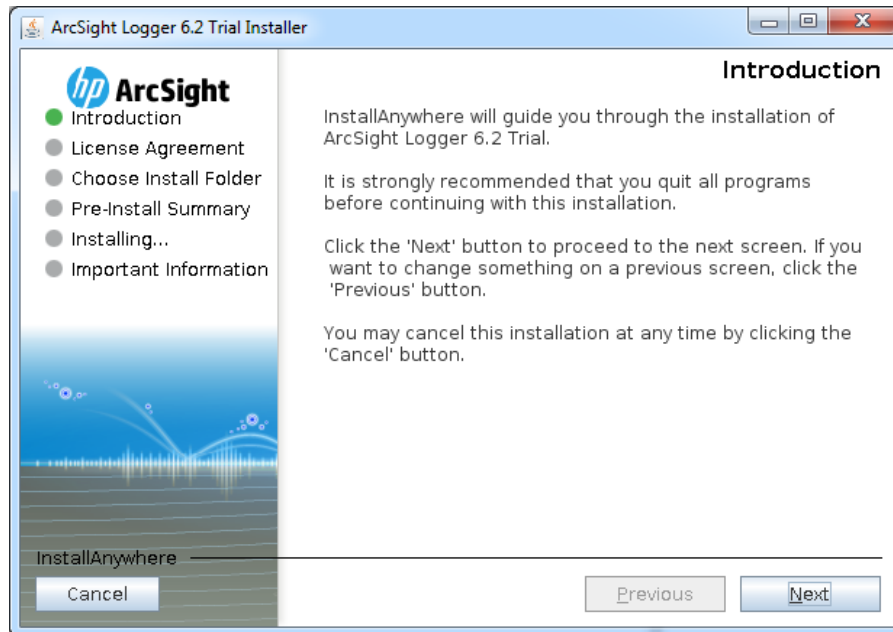

You can click **Cancel** to exit the installer at any point during the installation process.

Caution: Do not use the Ctrl+C to close the installer. If you use Ctrl+C to exit the installer and then uninstall Logger, uninstallation may delete your /tmp directory.

3. The License Agreement screen is displayed. Scroll to the bottom of the license agreement to review the agreement and enable the “I accept the terms of the License Agreement” button.
4. Select **I accept the terms of the License Agreement** and click **Next**.
5. The installer checks that installation prerequisites are met:
 - Operating system check—Logger Quick Start checks to see if your device is running a supported operating system. If you are not, a message displays, but it does not prevent you from installing Logger Quick Start software. This happens because some update scenarios start with an earlier OS.
 - Installation prerequisite check—If a check fails, Logger Quick Start displays a message. You will need to fix the issue before proceeding.
For example, if Logger Quick Start is currently running on this machine, an Intervention Required message is displayed. In that case, type Y and press **Enter** to stop all current Logger Quick Start processes and proceed with the installation, or type quit and press **Enter** to exit the installer.
6. Navigate to or specify the location where you want to install Logger Quick Start.
The default installation path for trial Logger Quick Start is /opt. You can install into this location or another location of your choice.

Note: The user you are installing with must have privileges to write to the installation directory and its sub-directories.

7. Click **Next** to install into the selected location.

- If there is not enough space to install the software at the location you specify, a message is displayed. To proceed with the installation, specify a different location or make sufficient space at the location you specified. Click **Previous** to specify another location or **Quit** to exit the installer.
- If Logger is already installed at the location you specify, a message is displayed. Click **Upgrade** to continue or **Previous** to specify another location. For upgrade instructions and information, refer to the Release Notes for your version.

8. Review the pre-install summary and then click **Install**.

Installation may take a few minutes. Please wait. Once installation is complete, the next screen is displayed.

9. **If you are logged in as root**, the following prompts are displayed. Fill in the fields and click **Next**.

Field	Notes
Non-root user name	This user must already exist on the system. Use the non-root user, arcsight, which comes preconfigured on your VM image.
HTTPS port	The port number to use when accessing the Logger UI. You can keep the default HTTPS port (443/tcp) or enter any other port that suits your needs. If you specify any port except 443/tcp, users will need to enter that port number in the URL they use to access the Logger UI.
Configure Logger as a service	Indicate whether to configure Logger to run as a service. Select this option to create a service called arcsight_logger, and enable it to run at levels 2, 3, 4, and 5. If you do not enable Logger Quick Start to start as service during the installation process, you can still do so later. For instructions on how to enable Logger to start as a service after installation, see the Logger Administrator's Guide.

10. Select the locale of this installation and click **Next**.

11. Click **Next** to initialize Logger components.

Initialization may take a few minutes. Please wait. Once initialization is complete, the next screen is displayed.

12. Click **Next** to configure storage groups and storage volume and restart Logger.

Configuration may take a few minutes. Please wait. Once configuration is complete, Logger starts up and the next screen displays the URL you should use to connect to Logger Quick Start.

13. Make a note of the URL and then click **Done** to exit the installer.

You can use the URL you noted during the installation to connect to Logger Quick Start and start configuring it to receive events. See ["Connecting to Logger Quick Start" on page 21](#).

Installing Trial Logger Quick Start for VMware VM

This section describes the procedure for installing Trial Logger Quick Start for VMware VM. For instructions on how to install Trial Logger Quick Start on a native Linux system, see ["Installing Trial Logger Quick Start on a Linux System" on page 14](#).

Installing Trial Logger Quick Start for VMware VM requires two basic steps:

- ["Preparing the Virtual Machine" below](#).
- ["Installing Trial Logger Quick Start for VMware VM" above](#).

Preparing the Virtual Machine

Before you can install the Logger Quick Start software, you must import and configure the VM. This section guides you through the steps of importing and configuring the VM. As part of the operating system configuration process, you will need to create a second hard disk before installing Logger Quick Start. After you add the second hard disk and power the system back on, the startup scripts attach the second hard disk and format it with an XFS partition. This partition will be used for storing the Logger Quick Start data.

Note: The following procedure is a guide for importing and deploying an OVA file. Your exact steps may vary depending on your particular ESXi environment and deployment tools. For more information about your particular environment and instructions on deploying the OVA file, consult your ESXi or system administrator.

To import the virtual machine:

1. Open the vSphere client and connect to the ESXi server.
2. On the vSphere client, open the File menu and select **Deploy OVF Template...** and click **Next**.
3. On the Source panel, browse to select the Logger Quick Start installation package (Logger_Quick_Start6.71_Trial_LXXXX_QXXXX.ova) that you downloaded previously. Click **Open** and then click **Next**.
4. The OVF Template Details panel displays product information and click **Next**.
5. On the Name and Location panel, enter a name for the virtual machine and click **Next**.
6. If there is more than one destination storage location available, select where to store the virtual machine. Click **Next**.
7. On the Disk Format panel select **Thick Provision Lazy Zeroed** and click **Next**.
8. The Ready to complete panel displays options you selected. Click **Finish** to confirm your selections and deploy the virtual machine.
A progress bar displays the deployment progress. When the deployment is complete, the VM you created is displayed in the ESXi server's list.

The pre-existing hard disk on the VM is for the Logger Quick Start software. You must create another virtual hard disk to store Logger Quick Start data.

To add a second hard disk:

1. Select the new VM from the ESXi server's list and make sure it is powered off.
2. Right-click the VM to open the dropdown menu, and then select **Edit Settings**.
3. The Virtual Machine Properties dialog box opens. Click **Add...**
The Device Type panel displays a list of devices you can add.
4. Select **Hard Disk** and click **Next**.
5. The Select a Disk panel displays the type of disks you can use. Select **Create a new virtual disk** and click **Next**.
6. The Create a Disk Panel displays virtual disk size and provisioning options.
 - Set the **Disk Size**.

Caution: Be sure to set the Disk Size as large as possible. You cannot expand the hard disk once created. The minimum size is 40 GB. The maximum size is 12 TB.

- Select **Thick Provision Lazy Zeroed**.
 - Click **Next**.
7. The Advanced Options panel displays other options. Keep the default Virtual device Node and click **Next**.
 8. The Ready to complete panel displays options you selected. Click **Finish** to confirm your selections and add the hard disk.
Once created, the new hard disk is displayed in the Hardware list.
 9. Click **OK** and Power on the new VM. The second hard disk is attached.

Installing the Trial Logger Quick Start on the Virtual Machine

The VM has the default root password `arcsight`. A non-root user, `arcsight`, with no password, is also included. This user is required for installation.

Caution: For security reasons and so that you can SCP or SSH to your machine, change the root password and add a password for the `arcsight` user as soon as possible.

Make sure the VM image is configured to comply with the requirements listed in the Release Notes for your version and that the prerequisites listed in "[Prerequisites for Installation](#)" on page 11 are met.

Preinstallation steps:

- Before you install, you must increase the user process limit on the OS, as described in ["Increasing the User Process Limit" on page 13](#).
- Verify that you have the correct installation file, as described in ["Before You Install" on page 10](#).

You can install Logger Quick Start as root or as a non-root user. See ["Prerequisites for Installation" on page 11](#) for details and restrictions.

Note: You must install into the /opt/arcsight/logger directory.

To install the Logger Quick Start software:

1. Run these commands from the /opt/arcsight/installers directory:

```
chmod u+x ArcSight-logger-6.2.0.L8213.1.trial.bin
./ArcSight-logger-6.2.0.L8213.1.trial.bin
```

2. The installation wizard launches in command-line mode. Press **Enter** to continue.

```
Introduction
```

```
-----
```

```
InstallAnywhere will guide you through the installation of ArcSight Logger
Quick Start 6.2 Trial.
```

```
It is strongly recommended that you quit all programs before continuing
with this installation.
```

```
Respond to each prompt to proceed to the next step in the installation. If
you want to change something on a previous step, type 'back'.
```

```
You may cancel this installation at any time by typing 'quit'.
```

```
PRESS <ENTER> TO CONTINUE:
```

3. The next several screens display the end user license agreement. Installation and use of Logger Quick Start 6.71 requires acceptance of the license agreement. Press Enter to display each part of the license agreement, until you reach the following prompt:

```
DO YOU ACCEPT THE TERMS OF THIS LICENSE AGREEMENT? (Y/N):
```

4. Type Y and press **Enter** to accept the terms of the License Agreement.

Tip: You can type quit and press **Enter** to exit the installer at any point during the installation process.

5. The installer checks that installation prerequisites are met:

- Operating system check—Logger Quick Start checks to see if your device is running a supported operating system. If you are not, a message displays, but it does not prevent you from installing Logger Quick Start software. This happens because some update scenarios start with an earlier OS.
- Installation prerequisite check—If a check fails, Logger Quick Start displays a message. You will need to fix the issue before proceeding.

For example, if Logger Quick Start is currently running on this machine, an Intervention Required message is displayed. In that case, type `Y` and press **Enter** to stop all current Logger Quick Start processes and proceed with the installation, or type `quit` and press **Enter** to exit the installer.

6. The Choose Install Folder screen is displayed. Type the installation path for Logger Quick Start and then press **Enter**.

The installation path on the VM image is `/opt/arcsight/logger`. You must install Logger Quick Start in this location. Do not specify a different location.

7. Type `Y` and press **Enter** to confirm the installation location.

8. If there is not enough space to install the software at the location you specify, a message is displayed. To proceed with the installation, specify a different location or make sufficient space at the location you specified. Type `quit` and press **Enter** to exit the installer and reconfigure your VM.

9. Review the pre-install summary and press **Enter** to install Logger Quick Start.

Installation may take a few minutes. Please wait. Once installation is complete, the next screen is displayed.

10. If you are logged in as root, the following prompts will be displayed. Type responses and press **Enter** after each.

Field	Notes
User Name	Use the non-root user, <code>arcsight</code> , which comes preconfigured on your VM image.
HTTPS Port	Enter the Logger Quick Start UI port number. You can keep the default HTTPS port (<code>443/tcp</code>) or enter any other port that suits your needs. If you specify any port except <code>443/tcp</code> , users will need to enter that port number in the URL they use to access the Logger Quick Start UI.
Choose if you want to run Logger Quick Start as a system service.	<ul style="list-style-type: none"> • Enter 1 to configure Logger Quick Start as a service. Select this option to create a service called <code>arcsight_logger</code>, and enable it to run at levels 2, 3, 4, and 5. If you do not enable Logger Quick Start to start as service during the installation process, you can still do so later. For instructions on how to enable Logger to start as a service after installation, see the Logger Administrator's Guide. • Enter 2 to configure Logger Quick Start as standalone.

11. Type the number that describes the desired locale, and press **Enter**.

12. Press **Enter** to initialize Logger Quick Start components.

Initialization may take a few minutes. Please wait. Once initialization is complete, the next screen is displayed.

13. Press **Enter** to configure storage groups and storage volume and restart Logger Quick Start automatically.

Configuration may take a few minutes. Please wait. Once configuration is complete, Logger Quick Start starts up and the next screen displays the URL you should use to connect to Logger Quick Start.

14. Make a note of the URL and then press **Enter** to exit the installer.

Now that you are finished installing and initializing your Logger Quick Start, you can use the URL you noted during the installation to connect to Logger Quick Start. For instructions and information, see ["Connecting to Logger Quick Start" below](#).

Connecting to Logger Quick Start

The Logger Quick Start user interface (UI) is a password-protected web browser application that uses an encrypted HTTPS connection. Refer to the ADP Support Matrix document available on the Protect 724 site for details on Logger Quick Start 6.71 platform and browser support.

Ensure that Logger Quick Start's publicly-accessible ports are allowed through any firewall rules that you have configured.

- For root installs, allow access to port 443/tcp as well as the ports for any protocol that the logger receivers need, such as port 514/udp for the UDP receiver and port 515/tcp for the TCP receiver.
- For non-root installs, allow access to port 9000/tcp as well as the ports for any protocol that the Logger Quick Start receivers need, such as port 8514/udp for the UDP receiver and port 8515/tcp for the TCP receiver.

Note: The ports listed here are the default ports. Your Logger Quick Start may use different ports.

JavaScript and cookies must be enabled.

To connect and log into Logger Quick Start:

1. Use the URL configured during Logger installation to connect to Logger Quick Start through a supported browser.

`https://<hostname or IP address>:<configured_port>`

where the `hostname or IP address` is the system on which the Logger Quick Start software is installed, and `configured_port` is the port set up during the Logger Quick Start installation, if applicable.

2. Once you connect, the following Login screen is displayed. Enter your user name and password,

and click **Login**.

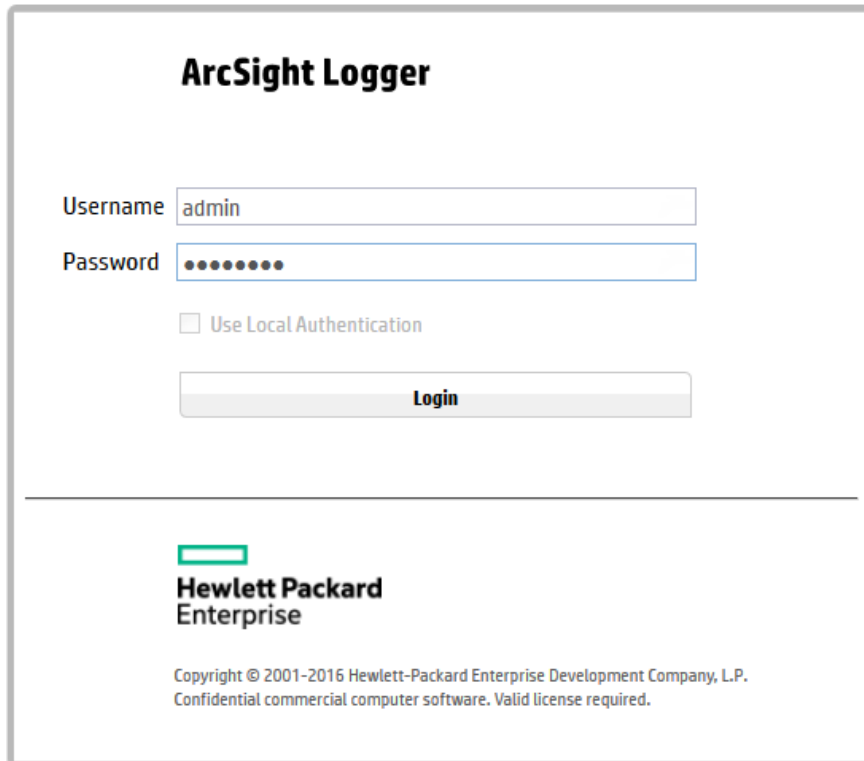

Use the following default credentials if you are connecting for the first time:

Username: admin

Password: password

Note: The first time you log in with the default user name and password, you will be required to change the password.

For more information about the log-in screen and connecting to Logger Quick Start, refer to the ArcSight Logger Quick Start Administrator's Guide.

Once you have logged in successfully, you can enable the preconfigured receivers and configure devices, device groups, and storage groups necessary to implement your retention policy. Go to ["Enabling the Preconfigured Receivers" on page 25](#) for information on how to set up your Logger Quick Start to start receiving events.

Initial Logger Quick Start Configuration

The Logger Quick Start initialization sets up the following default configuration. For details about the listed components, refer to the ArcSight Logger Quick Start Administrator's Guide.

Component	Default Configuration
Storage Volume	7 GB (available for data storage)
Storage Groups	<ul style="list-style-type: none"> • Default Storage Group • Internal Storage Group
Indexing	Full-text and field-based indexing enabled
Receivers	<ul style="list-style-type: none"> • TCP: 1 • UDP: 1 • SmartMessage: 1 • Folder Follower: 3 <p>For more information, see "Enabling the Preconfigured Receivers" on page 25.</p>

Starting and Stopping Logger Quick Start

The `loggerd` command enables you to start or stop the Logger Quick Start software running on your machine. In addition, the command includes a number of subcommands that you can use to control other processes that run as part of the Logger Quick Start software.

Note: If your Logger Quick Start is installed to run as a system service, you can use your operating system's service command to start, stop, or check the status of a process on Logger Quick Start.

```
<install_dir>/current/arcsight/logger/bin/loggerd
{start|stop|restart|status|quit}
```

```
<install_dir>/current/arcsight/logger/bin/loggerd {start <process_name> |
stop <process_name> | restart <process_name>}
```

To view the processes that can be started, stopped, or restarted with `loggerd`, click **System Admin** from the top-level menu bar. Then, under **System**, pick **Process Status**. The processes are listed on the right under **Processes**.

The following table describes the subcommands available with `loggerd` and their purpose.

Command	Purpose
<code>loggerd start</code>	Start all processes listed under the System and Process sections in the figure above. Use this command to launch Logger Quick Start.
<code>loggerd stop</code>	Stop processes listed under the Process section only. Use this command when you want to leave <code>loggerd</code> running but all other processes stopped.

Command	Purpose
<code>loggerd restart</code>	This command restarts processes listed under the Process section only. Note: When the <code>loggerd restart</code> command is used to restart Logger Quick Start, the status message for the “aps” process displays this message: Process ‘aps’ Execution failed. After a few seconds, the message changes to: Process ‘aps’ running.
<code>loggerd status</code>	Display the status of all processes.
<code>loggerd quit</code>	Stops all processes listed under the System and Process sections in the figure above. Use this command to stop Logger Quick Start.
<code>loggerd start <process_name></code>	Start the named process. For example, <code>loggerd start apache</code>
<code>loggerd stop <process_name></code>	Stop the named process. For example, <code>loggerd stop apache</code>
<code>loggerd restart <process_name></code>	Restart the named process. For example, <code>loggerd restart apache</code>

Uninstalling Logger Quick Start

If you will be uninstalling the trial Software Logger Quick Start over an SSH connection and want to use GUI mode, make sure that you have enabled X window forwarding using the `-X` option, so that you can view the screens of the uninstall wizard. If you will be using PuTTY, you will also need an X client on the machine from which you are connecting to the Linux machine.

Before uninstalling Logger, stop the Logger processes by using the `loggerd stop` command, as described in ["Starting and Stopping Logger Quick Start" on the previous page](#). To uninstall the Logger software, simply delete the VM. Alternatively, enter this command in the installation directory:

```
./UninstallerData/Uninstall_ArcSight_Logger_L8213_trial
```

The uninstall wizard launches. Click **Uninstall** or press Enter to start uninstalling Logger Quick Start.

Chapter 3: Receiving Events and Logs

Logger Quick Start comes preconfigured with several receivers that are ready to receive events and log files directly from devices and systems on your network, such as syslog servers, NFS, CIFS, or SAN systems.

Logger Quick Start can also receive events from ArcSight SmartConnectors that collect event data from sources on your network. A subset of ArcSight SmartConnectors is supported for Trial Logger Quick Start and available for download from the same location from which you downloaded Logger Quick Start. The Configuration Guides for the supported SmartConnectors are included and available at the same web site. To learn more about ArcSight SmartConnectors, visit <http://www8.hp.com/us/en/software-solutions/enterprise-security.html>.

- [Enabling the Preconfigured Receivers](#)25
- [Configuring New Receivers](#) 27

Enabling the Preconfigured Receivers

The default installation includes several receivers. To start receiving events, you can direct your event sources to the default receivers. After initialization, you can create additional receivers to listen for events. You can also change and delete receivers or disable and enable them as needed.

The following receivers are set up and enabled with the default installation:

- A **UDP** receiver: Enabled by default.
If you are installing Software Logger as root, the UDP receiver is on port 514/udp. For non-root installs, it is on port 8514/udp. If this port is already occupied, the initialization process selects the next higher unoccupied port.
This port should be allowed through any firewall rules you have configured.
- A **TCP** receiver: Enabled by default.
If you are installing Software Logger as root, the TCP receiver is on port 515/tcp. For non-root installs, it is on port 8515/tcp. If this port is already occupied, the initialization process selects the next higher unoccupied port.
This port should be allowed through any firewall rules you have configured.
- A **SmartMessage** receiver: Enabled by default. To receive events from a SmartConnector, download the SmartConnector and set the Receiver Name to **SmartMessage Receiver** when configuring the destination.

Logger Quick Start also comes preconfigured with folder follower receivers for Logger Quick Start's Apache URL Access Error log, the system Messages log, and the system Audit log (when auditing is enabled on your Linux OS). You must enable these receivers in order to use them.

Note: Logger Quick Start's Apache URL Access Error Log, `http_error_log`, is similar in format to the Apache `access_log`. Only failed access attempts are included in the Apache URL Access Error Log.

The preconfigured folder follower receivers include:

- Var Log Messages: `/var/log/messages`
- Audit Log: `/var/log/audit/audit.log`
- Apache URL Access Error Log: `<install_dir>/userdata/logs/apache/http_error_log`

Note: A folder follower receiver for the `/var/log/audit/audit.log` is only created if the folder `/var/log/audit/` already exists on your system at installation time.

When you first log in by using the URL you configured, the preconfigured folder follower receivers are disabled. The Home page displays an Add Data button. Click **Add Data** () to open the Receivers page and enable the receivers.













Tip: Before enabling these receivers, you must make `/var/log/audit/audit.log` and `/var/log/messages` readable by the non-root user you installed with or specified during Logger Quick Start installation.

Receivers



Once you enable the Apache URL Access Error Log receiver, Logger will start storing entries from the `<install_dir>/userdata/logs/apache/http_error_log` file.

Logger can also store entries from the messages and audit.log files in the `/var/log/*` folders. Before enabling the receivers for these files, consult the Logger Administrators guide for details.

Name	Type	IP Address	Port	
Apache URL Access Error Log	Folder Follower Receiver			  
Audit Log	Folder Follower Receiver			  
AusmReceiver1	TCP Receiver	All	30001	  
AusmReceiver101	CEF TCP Receiver	All	30101	  

To enable a receiver, click the disabled icon () at the end of the row.

Alternately, you can navigate to the Receivers page from the menu to enable the receivers.

To open the Receivers page from the menu and enable a receiver:

1. Open the **Configuration | Data** menu and click **Receivers**.
2. Identify the receiver you want to enable, and click the disabled icon (🚫) at the end of that row.

Once you enable the receivers, you should see events coming into your system from those logs. For more information about receivers, refer to the ArcSight Logger Quick Start Administrator's Guide.

Configuring New Receivers

In addition to the out-of-box receivers, you can configure other receivers to meet your needs. Receiver types include UDP, TCP, SmartMessage, and three types of file follower, File Transfer, File Receiver, and Folder Follower Receiver.

You can configure the following types of receiver for Logger Quick Start:

- **UDP Receiver:** UDP receivers listen for User Datagram Protocol messages on the port you specify. The pre-installed UDP receiver is enabled by default.
- **CEF UDP Receiver:** UDP receivers that receive events in Common Event Format.
- **TCP Receiver:** TCP receivers listen for Transmission Control Protocol messages on the port you specify. The pre-installed TCP receiver is enabled by default.
- **CEF TCP Receiver:** TCP receivers that receive events in Common Event Format.
- **File Receiver:** Depending on the type of Logger Quick Start, file receivers read log files from a local file system, Network File System (NFS), Common Internet File System (CIFS), or Storage Area Network (SAN). File receivers read single or multi-line log files. They provide a snapshot of a log file at a single point in time.
- **Folder Follower Receiver:** Folder follower receivers actively read the log files in a specified directory as they are updated. If the source directory contains different types of log files, you can create a receiver for each type of file that you want to monitor. To start using the pre-installed folder follower receivers you must enable them.
- **File Transfer:** File Transfer receivers read remote log files using Secure Copy Protocol (SCP), Secure file transfer protocol (SFTP), or File Transfer Protocol (FTP) protocol. These receivers can read single- or multi-line log files. You can schedule the receiver to read a file or batch of files periodically.

Caution: The SCP and SFTP protocols on Logger Quick Start appliances are not FIPS compliant.

Note: The SCP, SFTP, and FTP file transfer receivers depend on the FTP, SCP, and SFTP clients installed on your system.

- **SmartMessage Receiver:** SmartMessage receivers listen for encrypted messages from ArcSight SmartConnectors. To start using the pre-installed receiver, you must configure a SmartConnector to

send events to it. For instructions, see "[Configuring a SmartConnector to Send Events to Logger Quick Start](#)" below.

- [Sending Structured Data to Logger Quick Start](#)28
- [Configuring a SmartConnector to Send Events to Logger Quick Start](#)28

Sending Structured Data to Logger Quick Start

Although Logger Quick Start is message-agnostic, it can do more with messages that adhere to the Common Event Format (CEF), an industry standard for the interoperability of event- or log-generating devices. Events in Common Event Format (CEF) have more columns defined, making the data more useful.

Logger Quick Start can receive structured data in the form of normalized CEF events from ArcSight SmartConnectors, as shown in the illustration in "[How Logger Quick Start Works](#)" on page 7.

For more information about the Common Event Format (CEF), refer to Implementing ArcSight CEF. For a downloadable a copy of this guide, search for "ArcSight Common Event Format (CEF) Guide" in the [ArcSight Product Documentation Community on Protect 724](#).

Configuring a SmartConnector to Send Events to Logger Quick Start

Logger Quick Start comes pre-configured with a SmartMessage Receiver. To use it to receive events from a SmartConnector, you must configure the SmartConnector as described below. You can also create new SmartMessage receivers and configure the SmartConnectors with these newly created receivers. When configuring a SmartConnector, be sure to specify the correct receiver name.

To configure a SmartConnector to send events to Logger Quick Start:

1. Install the SmartConnector component using the SmartConnector User's Guide as a reference. Specify Logger Quick Start as the destination instead of ArcSight ESM or a CEF file.

Note: Refer to the documentation that came with your SmartConnector for instructions.

2. Specify the required parameters. Enter the Logger Quick Start hostname or IP address and the name of the SmartMessage receiver. These settings must match the receiver in Logger Quick Start that listen for events from this connector.
 - To use the preconfigured receiver, specify "SmartMessage Receiver" as the **Receiver Name**.
 - To use SmartMessage to communicate between an ArcSight SmartConnector and a Logger Quick Start Appliance, configure the SmartConnector to use port 443/tcp.

- To communicate between an ArcSight SmartConnector and Software Logger Quick Start, configure the SmartConnector to use the port configured for the Software Logger Quick Start.
- For unencrypted CEF syslog, enter the Logger Quick Start hostname or IP address, the desired port, and choose UDP or TCP output.

Chapter 4: Overview of the Logger Quick Start User Interface

This section provides a high-level view of the Logger Quick Start User Interface, with an emphasis on the Search interface. For more information and for user interface options not discussed in this section, refer to the ArcSight Logger Quick Start Administrator’s Guide.

- [Navigating the User Interface](#)30
- [Summary](#) 33
- [Dashboards](#) 33

Navigating the User Interface

A navigation and information band runs across the top of every page in the user interface. It contains menu tabs, a quick navigation field, events gauges, system clock, and a menu including Options, Help, About, and Logout.

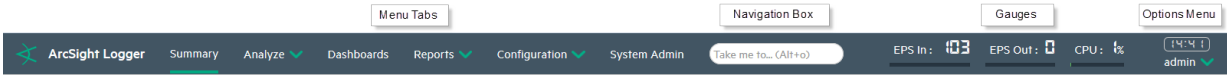

Bar gauges at the top of the screen provide an indication of the throughput and CPU usage information available in more detail on the Monitor Dashboard ("[Dashboards](#)" on page 33). You can change the range of the bar gauges on the Options page. The name of the logged-in user is shown below the clock, to the right of the gauges.

- [Take Me To](#)30
- [Server Clock, Current User, and Options Dropdown](#) 31
- [Logout](#) 32

Take Me To

To the right of the menu tabs, the **Take me to...** navigation box provides a quick and easy way to navigate to any location in the user interface (UI). The Take me to... feature enables you to navigate to any Logger Quick Start feature simply by starting to type the feature’s name.

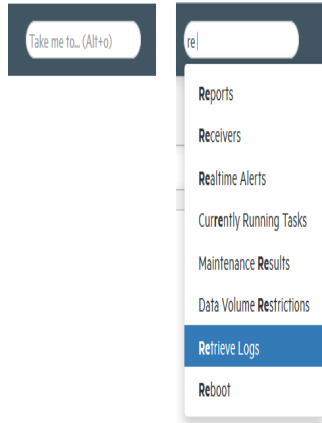

You can access the Take me to... navigation box by clicking in it or by using the Alt+o, Alt+p, or Ctrl+Shift+o hot keys. As you type, a list of features that match drops down. Click an item in the list or press enter to go to the specified feature.

Note: You can open the help for your current UI page by typing help in the **Take me to...** search box.

Server Clock, Current User, and Options Dropdown

The server clock is shown to the right of the bar gauges, along with the currently logged-in user's name and the options dropdown.

The server clock displays the Logger Quick Start server's system time. This may be different from the user's local time. Click the down-arrow by the user name to access the Options, Help, About, and Logout links.

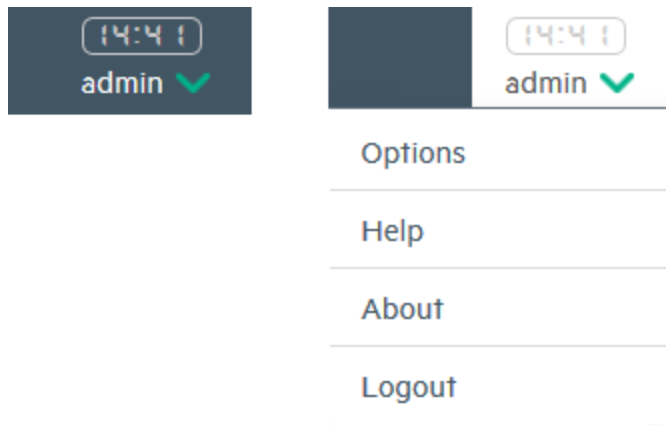

The Options Page

The Options page allows you to set the range on the EPS In and EPS Out bar gauges. If the event rate exceeds the specified maximum, the range is automatically increased.

Options

System

EPS input rate bar gauge max

EPS output rate bar gauge max

Default start page for all users

Upload a logo (PNG file) No file selected.

Show default logo

Personal

Default start page for admin

From here, you can **Upload a logo (.png file)** and replace the ArcSight Logger Quick Start logo with your custom logo. The logo must be in .png format. The recommended size is 150 x 30 px and the maximum file size is 1 MB.

Additionally, you can set the default start page (home page) for all users and specific start pages for individual users here. The start page is the user interface page Logger displays when a user logs in.

Logout

Click the Logout link on any page to return to the Login screen. Logging out is good security practice, to eliminate the chance of unauthorized use of an unattended Logger Quick Start session.

Logger Quick Start automatically logs you out after a user-configurable length of time (15 minutes by default). To change this length of time, refer to the ArcSight Logger Quick Start Administrator's Guide.

Summary

The Summary page is a global dashboard that provides summarized event information about your Logger Quick Start in one screen. It enables you to gauge incoming events activity and the status of indexing.

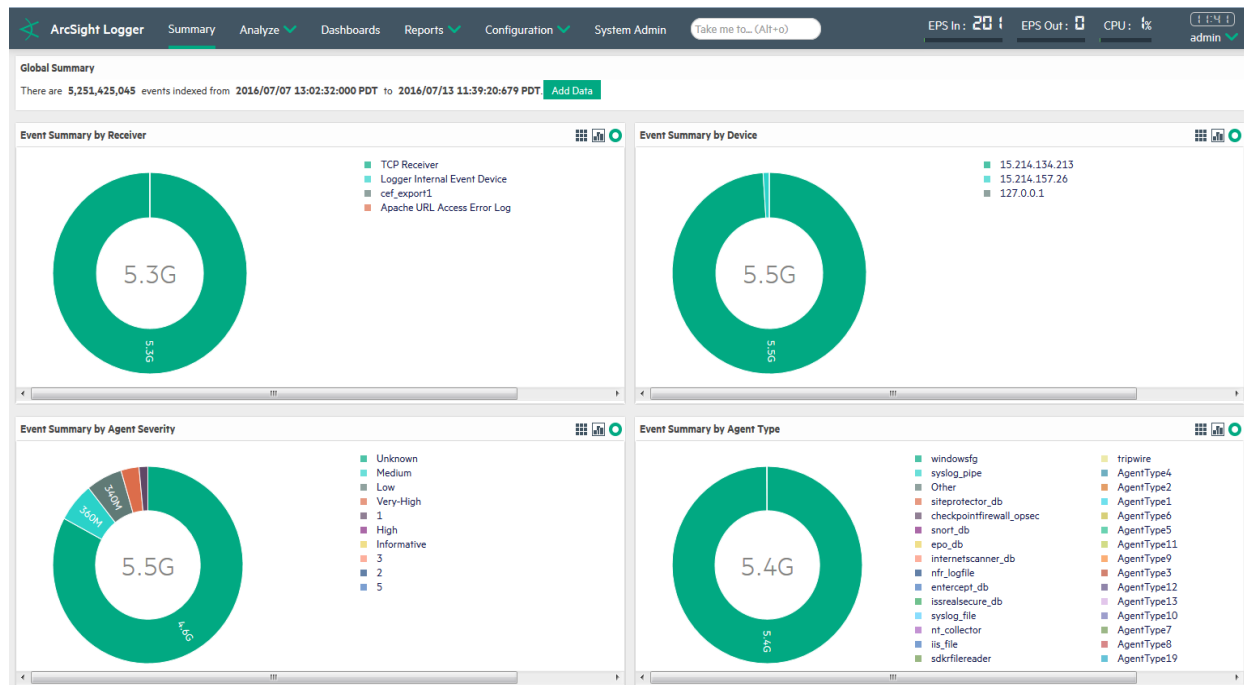

Dashboards

Dashboards are an all-in-one view of the Logger Quick Start information of interest. You can assemble various search queries that match events of interest to you, status of Logger Quick Start components such as receivers, forwarders, storage, CPU, and disk, or a combination of both on a single dashboard.

Each Dashboard contains one or more panels of these types: Search Results and Monitor. The Search Results panels display events that match the query associated with the panel. The Monitor panels display the real-time and historical status of various Logger Quick Start components such as receivers, forwarders, storage, CPU, and disk.

For more details about Dashboards, refer to the ArcSight Logger Quick Start Administrator's Guide.

Chapter 5: Searching for Events

Once Logger Quick Start has stored events from heterogeneous sources on your network, you can search through those events for a wide array of uses such as unsuccessful login attempts, the number of events by source, SSH authentications. *Additionally, you might want to include matching events in a report, or forward events to another system such as ArcSight ESM.*

You need to create queries to search for events. Queries can be as simple as a term to match, such as “login” or an IP address; or they can be more complex, such as events that include multiple IP addresses, ports, and occurred between specific time ranges from devices that belong to a specific device group.

Searching through stored events is very simple and intuitive on Logger Quick Start. It uses a flow-based search language that allows you to specify multiple search commands in a pipeline format. In addition, you can customize the display of search results, view search results as charts, and so on.

Example Queries

Simple query examples:

- error
- sourceAddress=192.0.2.0
- hostA.companyxyz.com

Complex query example:

```
_storageGroup IN ["Default Storage Group"] _deviceGroup IN ["192.168.22.120 [TCPC]"] name="*[4924TestAlert]*" AND ("192.168.*" OR categoryBehavior CONTAINS Stop) | REGEX=":\d31" | cef name deviceEventCategory | chart _count by name
```

Syntax of a Query

A Logger Quick Start search query contains one or more of the following types of expressions:

Query Element	Description
Keyword expression	<p>A keyword: a word expressed in plain text; for example:</p> <pre>warning failed login</pre>
Field-based expression	<p>A field-based expression: searching for values in the fields of an event. This includes searches for uncommon values in specific fields; for example:</p> <pre>name="failed login" message!="failed login" sourceAddress=192.0.2.0</pre>
<i>Search operator expression</i>	<p>A search operator expression: an expression that uses search operators to refine the data that matches the expressions specified by the keyword and the field-based expression.</p> <p><i>The following search operators are available in Logger Quick Start 6.71:</i></p> <pre>cef, chart, dedup, eval, extract, fields, head, keys, rare, regex, rename, replace, rex, sort, tail, top, transaction, where</pre>
<i>Extraction operator expression</i>	<p>The rex search operator is useful for syslog events (raw or unstructured data) or if you want to extract information from a specific point in an event, such as the 15th character in an event.</p> <p>For example, to extract an IP address from the following event:</p> <pre>[Thu Jul 30 01:20:06 2009] [error] [client 69.63.180.245] PHP Warning: Can't connect to 10.4.31.4:11211</pre> <p>and assign it to a field called "IP_Address", use the following rex expression:</p> <pre> rex "(?<IPAddress>\d{1,3}\.\d{1,3}\.\d{1,3}\.\d{1,3})"</pre>
<i>Implied field extraction operator</i>	<p>You can specify the event fields directly in queries; for example:</p> <p>To display search results of the count of unique values device addresses in a chart form:</p> <pre>failed chart _count by deviceAddress</pre> <p>To display search results of the most common values for the deviceAddress field in table form. That is, the values are listed in order from the highest number of matches to the lowest.</p> <pre>failed top deviceAddress</pre>

For detailed usage and examples of the search expressions, refer to the ArcSight Logger Quick Start Administrator's Guide.

Building a Query

When you build a query, you must specify the following elements:

- **Query Expression:** the search conditions to use when selecting or rejecting an event.
- **Time range:** the time range within which to search.
- **Field Set:** the fields of an event to display for matching events; for example, you can select to display only the `deviceAddress` and `deviceReceiptTime` fields of matching events.

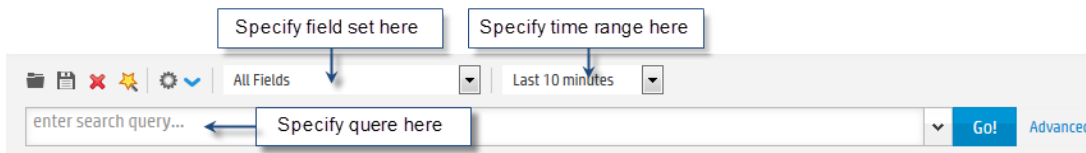

In addition, you can also include constraints that limit the search to specific device groups and storage groups. For more information about specifying constraints, refer to the ArcSight Logger Quick Start Administrator's Guide.

- A Storage Group enables you associate a retention policy with it. Therefore, by defining multiple storage groups, you can store events for different periods of time.
- A Device Group enables you to categorize devices of your choice into a group. You can associate a device group to a storage rule that defines in which storage group events from a specific device group are stored.

Run a Query

To run a query:

1. Click **Analyze > Search**.
2. Specify the query expression in the Search text box.
3. Select the time range and (optionally) the field set.
4. Click **Go**.

Tip: If you receive syntax error when running a query, ensure that the syntax of the query follows the requirements specified in the "Syntax Reference for Query Expression" section of the ArcSight Logger Quick Start Administrator's Guide.

Query Building Tools

Logger Quick Start offers the following tools to assist you in building queries that are complex:

- Search Builder

The Search Builder tool is a Boolean-logic conditions editor that enables you to build search queries quickly and accurately. The tool provides a visual representation of the conditions you are including in a query. You can specify keywords, field-based conditions, and regular expressions using this tool. In addition, the tool enables you to specify search constraints such as device groups and storage groups.

Click **Advanced Search** below the Search text box to access this tool. For information about how to use this tool, refer to the ArcSight Logger Quick Start Administrator's Guide.

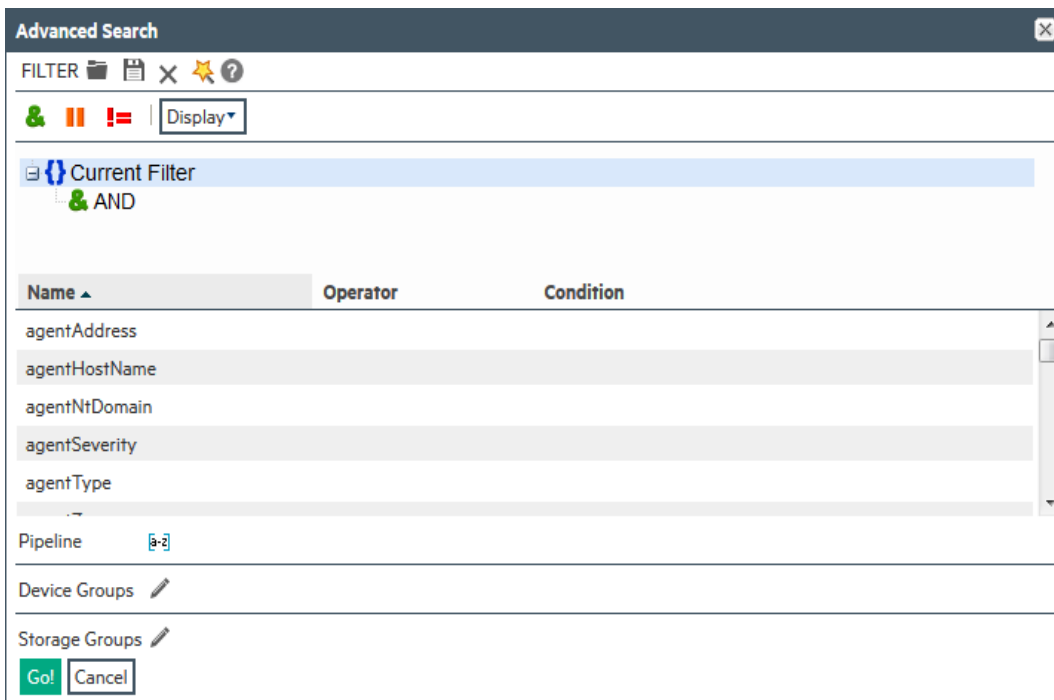

- Regex Helper

Creating a regular expression for the rex extraction operator can be complex and error prone. The Regex Helper tool enables you to create regular expressions to use with the rex pipeline operator to extract fields of interest from an event. This tool not only simplifies the task of creating regular expressions for the rex operator but also makes it efficient and error free. For details about this tool, refer to the ArcSight Logger Quick Start Administrator's Guide.

- Search Helper

Search Helper is a search-specific utility that provides the following features:

- **Search History:** Displays the recently run queries on Logger Quick Start, thus enabling you to select and reuse previously run queries without typing them again.
- **Search Operator History:** Displays the fields used previously with the search operator you have entered in the Search text box.
- **Examples:** Lists examples relevant to the latest query operator you entered.
- **Suggested Next Operators:** List of operators that generally follow the current query. For example, if you type `logger`, the operators that often follow are `rex`, `extract`, or `regex`.
- **Help:** Provides context-sensitive help for the last-listed operator in your query.
- **List of Fields and Operators:** Depending on the query you enter, Logger Quick Start displays either a complete list of fields that possibly match the field name you are typing, or a list of available operators.

Exporting Search Results

You can export search results in these formats:

- PDF: Useful in generating a quick report of the search results. The report includes a table of search results and any charts generated for the results. Both raw and CEF events can be included in the exported report.
- Comma-separated values (CSV) file: Useful for further analysis with other software applications. The report includes a table of search results. Charts cannot be included in this format.

To export search results:

1. Run a search query.
2. Click **Export Results**. 

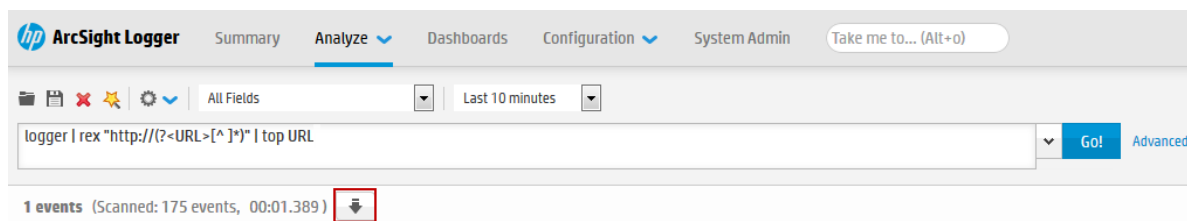

Saving Queries for Later Use

If you need to run the same query regularly, you can save it in two ways:

- Saved filter: Save the query expression, but not the time range or field set information.
- Saved search: Save the query expression and the time range.

For more information about saving queries and using them again, refer to the ArcSight Logger Quick Start Administrator's Guide.

System Filters (Predefined Filters)

Your Logger Quick Start ships with a number of predefined filters, also known as system filters. These filters define queries for commonly searched events such as unsuccessful login attempts or the number of events by source.

To use a system filter:

1. Click **Analyze > Search**.
2. Click the Load a Saved Filter icon () to view a list of all system filters.

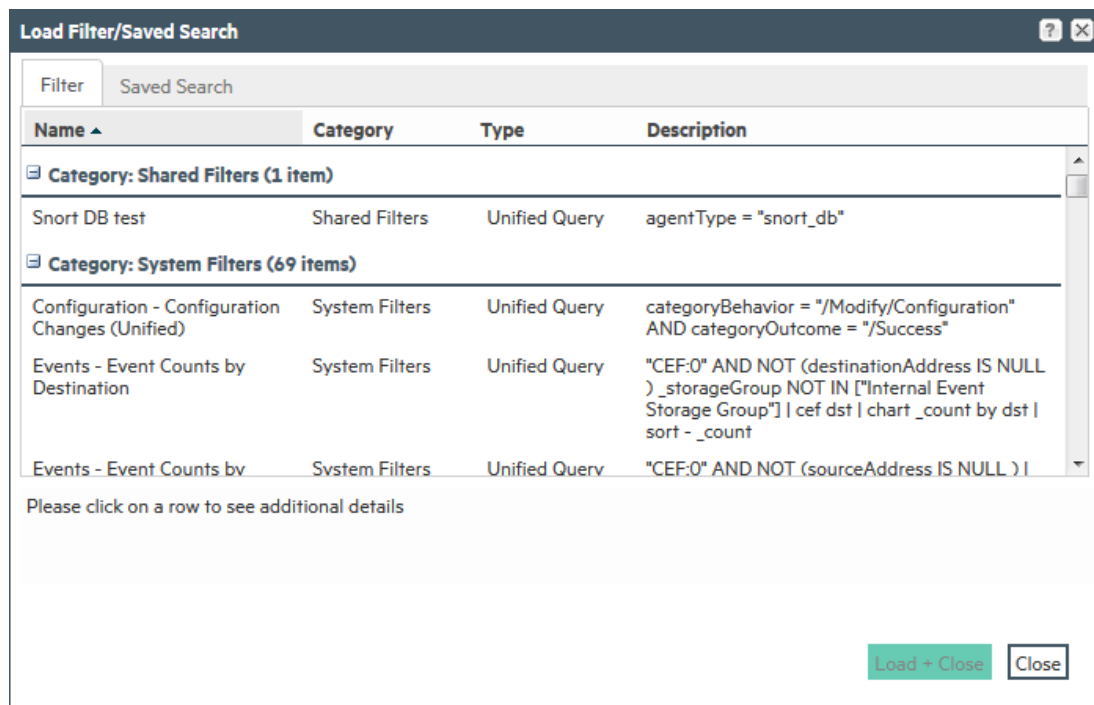

3. Click **Load+Close**.

Tuning Search Performance

Search performance depends on many factors and will vary from query to query. Some factors that can affect search performance are listed below.

To optimize search performance, ensure that you follow these recommendations:

- Take advantage of super indexes where possible, for the fastest search results. Refer to the ArcSight Logger Quick Start Administrator's Guide for more information on how to search super-indexed fields.
- The amount of time it takes to search depends on the size of the data set that must be searched, the complexity of the query, and whether the search is distributed across peers. To limit the data set, ensure that time range you specify does not result in a query that needs to scan multi-millions of events.
- Limiting search to specific storage groups or peers typically results in better search performance than when the storage groups or peers are not specified.
- Reduce the load on the system when your query needs to run, for example, scheduled jobs, *running multiple reports*, or large number of incoming events.

Tip: Full-text indexing and Field-based indexing for a recommended set of fields are automatically enabled at Logger Quick Start initialization time. In addition to these fields, Micro Focus strongly recommends that you index fields that you will be using in search *and report* queries. Refer to the ArcSight Logger Quick Start Administrator's Guide for more information on indexing fields.

Chapter 6: Alerts

You can configure your Logger Quick Start to alert you by e-mail, an SNMP trap, or a Syslog message when a new event that matches a specific query is received or when a specified number of matches occur within a given time threshold.

You can also view the alerts through the Alert sub-menu pull down under the Analyze tab. When an alert is triggered, Logger Quick Start creates an alert event and sends a notification to the destinations you configured previously.

- [Types of Alerts](#)41
- [Configuring Alerts](#)42

Types of Alerts

Logger Quick Start provides two types of alerts:

- Real time alerts
- Saved Search Alerts

The following table compares the two types of alerts.

Real Time Alerts	Saved Search Alerts
No limit on the number of alerts that can be defined. A maximum of 25 alerts can be enabled at any time.	Any number of alerts can be defined. All defined alerts are enabled and effective; however, a maximum of 50 alerts can run concurrently.
No limit on the number of configured e-mail destinations; however, you can only set one SNMP, one Syslog, and one ESM destination.	No limit on the number of configured e-mail destinations; however, you can only set one SNMP, one Syslog, and one ESM destination.

Real Time Alerts	Saved Search Alerts
<p>Alerts are triggered in real time. That is, when specified number of matches occurs within the specified threshold, an alert is immediately triggered.</p>	<p>These alerts are triggered at scheduled intervals. That is, when a specified number of matches occurs within the specified threshold, an alert is triggered at the next scheduled time interval.</p>
<p>Only regular expression queries can be specified for these alerts.</p>	<p>Queries for these alerts are defined using the flow-based search language that allows you to specify multiple search commands in a pipeline format, including regular expressions. Aggregation operators such as chart and top cannot be included in the search query.</p>
<p>To define a real time alert, you specify a query, match count, threshold, and one or more destinations.</p> <p>A time range is not associated with the queries defined for these alerts. Therefore, whenever the specified number of matches occurs within the specified threshold, an alert is triggered.</p>	<p>To define a Saved Search Alert, you specify a Saved Search (which is a query with a time range), match count, threshold, and one or more destinations.</p> <p>A time range (within which events should be searched) is specified for the query associated with these alerts. Therefore, specified number of matches within the specified threshold (in minutes) must occur within the specified time range. You can also use dynamic time range (for example, \$Now-1d, \$Now, and so on).</p> <p>For example, if a Saved Search query has these start and end times:</p> <p>Start Time: 5/11/2016 10:38:04 End Time: 5/12/2016 10:38:04</p> <p>And, the number of matches and threshold are the following:</p> <p>Match Count: 5 Threshold: 3600</p> <p>An alert will trigger if five or more events occur in one hour anytime between May 11th, 2016 10:38:04 a.m. and May 12th, 2016 10:38:04 a.m.</p>

Configuring Alerts

Refer to the ArcSight Logger Quick Start Administrator's Guide for detailed instructions on how to create both types of alerts.

Chapter 7: Other Logger Quick Start Features

In addition to the Logger Quick Start features highlighted in this guide, Logger Quick Start provides many other features. This section provides an overview of some of those features. For an in-depth understanding and how to use Logger Quick Start, refer to the ArcSight Logger Quick Start Administrator’s Guide and ArcSight Logger Quick Start Web Services API Guide.

- [Scheduling Tasks](#)43
- [Archiving Events](#)43
- [Access Control on Logger Quick Start Users](#)43
- [Enriching Data Through Static Correlation](#)44
- [Web Services](#)44

Scheduling Tasks

You can configure Logger Quick Start to run jobs such as Configuration Backup, Event Archive, File Transfers, and Saved Searches on recurring basis.

Archiving Events

Event Archives let you save the events for any day in the past, not including the current day. The archive location can be a local directory or a mount point that you have already established on the system on which Logger Quick Start software is installed. You can also schedule a daily archive of the events. Index information is not included in event archives. However, you can index an archive after it has been added. This will enable searches on archived events to be as fast as searches in live storage.

Access Control on Logger Quick Start Users

You can create users with different access privileges on Logger Quick Start. For example, you create Joe with only Logger Quick Start search privileges and give Jane Logger Quick Start search and administration capabilities.

Enriching Data Through Static Correlation

The Lookup feature enables you to augment data in Logger Quick Start with data from an external file, and display this data in the Search results. This enables geo-tagging, asset tagging, user identification, and so on, through static correlation. For example, if you want the search results to include which country source IP addresses are located in, you can create a file listing the IP addresses and countries and then upload that file to Logger Quick Start as a Lookup file. After that, you can use the `Lookup` search operator to correlate the `sourceAddress` field in the events and the IP address column in the Lookup file, and display the country in the search results.

Web Services

Logger Quick Start includes SOAP and REST web services that you can use to integrate Logger Quick Start functionality in your own applications. For example, you will be able to create programs that execute searches on stored Logger Quick Start events or run Logger Quick Start reports, and feed them back to your third-party system. Refer to the Logger Quick Start Web Services API guide for more information on this feature.

Chapter 8: Example Queries

This section provides a few example queries that you can use on Logger Quick Start. These queries assume that your Logger Quick Start is receiving and storing events. You can also modify these queries to suit your needs.

Tip: To form a rex expression, use the Regex Helper tool available on your Logger Quick Start. For details about the Regex Helper tool, refer to the ArcSight Logger Quick Start Administrator's Guide.

- Extract the IP address from any event that contains the word “failed” and show the top IP addresses:

```
failed | rex “(?<src_ip>[^\d{1,3}\.\d{1,3}\.\d{1,3}\.\d{1,3})” | top  
<src_ip>
```

- Extract the network ID from an IP address:

The IP address is captured by the first rex expression and the network ID (assuming the first three bytes of the IP address represent it) to which the IP address belongs is extracted from the captured IP address:

```
error | rex “(?<src_ip>[^\d{1,3}\.\d{1,3}\.\d{1,3}\.\d{1,3})” | rex  
field=src_ip “(?<net_id>\d{1,3}\.\d{1,3}\.\d{1,3})”
```

- Extract all URLs from events and generate a chart of the URL counts, excluding blank URLs:

```
http | rex “http://(?<customURL>[^\s]*)” | where customURL is not null |  
chart _count by customURL | sort - _count
```

- Extract the first word after the word “user” (one space after the word) or “user=”:

The word “user” is case-insensitive in this case and must be preceded by a space character. That is, words such as “ruser” and “suser” should not be matched.

```
user | rex “\s[u|U][s|S][e|E][r|R][\s|=](?<CustomUser>[^\s]*)” | chart _  
count by CustomUser
```

Send Documentation Feedback

If you have comments about this document, you can [contact the documentation team](#) by email. If an email client is configured on this computer, click the link above and an email window opens with the following information in the subject line:

Feedback on Quick Start Guide (Logger Quick Start 6.71)

Just add your feedback to the email and click send.

If no email client is available, copy the information above to a new message in a web mail client, and send your feedback to arcsight_doc@microfocus.com.

We appreciate your feedback!